



**RIC-S28DN**

**廚房專用單頭電磁爐 Kitchen Use Single-Burner Induction Cooker**



**僅供家庭使用**  
**For household use only**

# 使用說明書

## OPERATION MANUAL

- 在使用本產品前，請仔細閱讀本說明書，並妥善保存本說明書以備用戶日後查詢。  
Read the operation manual carefully before using and well keep it in a safe place for future reference.
- 本說明書中的圖示可能有與實物不同的地方，僅供參考。  
Some figures in this manual may not match with the real object, just for reference only.

非常感謝您選購樂信牌廚房專用單頭電磁爐，使用前請先詳細閱讀本說明書，並保存以備日後參考。

## 目錄

1. 安全注意事項
2. 保養及清潔方法
3. 鍋具的選擇
4. 產品規格及結構
5. 控制面板及操作方法
6. 故障排除
7. 特別聲明
8. 售後服務

## 1. 安全注意事項

使用本產品時，必須遵守下列安全預防措施。不當使用，可導致個人傷亡及財物損失。

### 1.1 為了防止火災、灼傷和觸電

#### 使用電磁爐前

1. 切勿與其他電器共用同一電源，並確保使用地的電壓與本產品上所標明的額定電壓相符。
2. 切勿使用電線拖板，以免因電力負荷過度而導致火警或危險。

#### 安裝電磁爐時

1. 2800瓦的單頭電磁爐，必須將原裝電線連插頭接駁至13安培獨立插座上。如需接駁至固定線路上，必須為13安培或以上的獨立開關掣，並須符合電力條例。
2. 應把產品平穩放置於乾爽的地方，並距離牆壁大於100毫米以上的距離空間作散熱用途。嵌入式安裝時，電磁爐底部須預留不少於150毫米高度，而櫥櫃門亦須有不少於80平方厘米的進／出風口，並請保持排氣口及進風口暢通。

#### 使用電磁爐烹煮時

1. 切勿過度加熱。(使用低火力段預熱。)
  - 如果油量少並且加熱過度，則可能因油溫迅速上升而導致鍋底結焦或火災發生。
  - 如果鍋具底部很薄且彎曲，則鍋具底部可能會變紅。
2. 切勿讓產品置於無人看管的狀態下運作，特別是使用油脂在爐灶上進行烹飪時，可能會造成危險或導致火災。
3. 切勿乾燒空鍋，否則容易造成過熱、工作異常及面板變色等問題。
4. 烹飪過程必須受到監督。短期烹飪過程亦必須持續監督。

#### 面板及邊框可能變得極熱

1. 在使用時或剛使用後，切勿觸摸。  
(在[餘溫]提示燈亮起時，尤其要小心。)
2. 待冷卻後才清潔本產品。  
(避免在使用後的短時間內觸摸面板，因為鍋具的溫度會令面板仍然保持高溫。)

#### 關於面板

1. 切勿將物品存放在加熱區，或將攜帶式氣體爐、石油氣罐及罐裝食品放在電磁爐面板上，以防止它們被錯誤加熱而造成爆炸。
2. 使用說明書內建議的合適鍋具及確保鍋具底部保持平整及清潔。否則，面板感測器可能失效並導致產品異常升溫或出現故障。
3. 切勿在電磁爐運行時，將類似刀、叉、湯匙、蓋子、鋁箔或鋁盤等金屬物或導磁性物品，以及蒸煮袋、磁性指環、手錶或飾物等置於面板上或面板附近，或直接接觸鍋具，否則可能造成該物品變熱。(被加熱時所產生的熱量，會造成灼傷或受傷。)
4. 切勿讓面板受到重壓或外來的猛烈撞擊。(例如重物墜於面板上，可能導致面板暗處產生裂紋。在沒有接受信興電器服務中心有限公司詳細檢查期間，如產品再度強行運作，可能促使面板爆裂，產生危險。)

\*\*\* **警告！**如果面板破裂或受到外來的猛烈撞擊或因重物墜落造成破裂，切勿觸摸。應立即停止使用並關掉電源及拔出電源插頭，立即聯絡信興電器服務中心有限公司進行檢查及維修，以避免造成電擊、短路或火災等危險。

## 鍋具注意事項

1. 電磁爐專用的鍋具只能放在電磁爐上使用。切勿將電磁爐專用的鍋具用於氣體煮食爐上或混合使用，以免影響烹調效果。
2. 放置鍋具前，必須確認鍋具底部及面板沒有水漬、油漬或其他粘附物。如有，應完成清潔後才使用本產品。

## 請避免油炸烹飪

1. 本產品不帶油溫控制系統。油炸時，或會因油溫過高而導致火災及損壞內部電子組件；應緩慢加熱，並時刻留意加熱情況。
2. 若油脂於加熱時起火，應立即關閉電源。切勿用水滅火，應使用合適的滅火器或使用滅火毯。

## 電磁爐爐頭注意事項

1. 切勿將本產品安裝或放置在金屬檯面(或金屬表面)上使用，以免導致金屬材料或檯面被錯誤加熱而引起產品機殼發熱，造成危險。
2. 切勿將易燃材料、噴霧劑及煙霧劑等置於產品下方或附近，否則可能導致火災或爆炸。
3. 切勿讓不習慣操作本產品的人獨自使用。
4. 本產品並不為體質、感覺或智力有障礙人士或缺乏經驗(包括小孩)或相關知識的人士使用，除非他們曾經接受負責安全人士的監督或指示。
5. 切勿加熱密封的罐頭食品，以防罐頭受熱膨脹，發生爆炸。
6. 請時常留意烹調情況，避免過熱或乾燒。否則，溫度過高會使產品的安全保護功能自動啟動並停止運作，影響烹調效果。
7. 若有孩童在旁，須加倍小心使用產品及看管小孩，以確保他們不會將此產品當作玩具。切勿讓小孩單獨使用及將本產品及其電源線置於他們可能觸及的地方。
8. 切勿讓嬰兒靠近。
9. 切勿將金屬物件(如針或金屬線等)插入產品的進風口／排氣口。
10. 切勿使用外置計時器或遙控系統來操作本產品。
11. 鍋具與面板中間不應夾雜紙品或其他物件，讓鍋具底部能夠直接受熱。(由於鍋具的熱量，該物件或會因此而燒毀。)
12. 煮食時，鍋具必須放置於加熱區的中央位置上面。
13. 切勿拆卸、試圖維修或改裝本產品，以免釀成意外。如須檢查或維修，請與信興電器服務中心有限公司聯絡。
14. 如發現附帶的電線有破損，必須聯絡信興電器服務中心有限公司更換，以免發生危險。

## 使用後，須切斷產品的電源

1. 使用後，必須按[電源]鍵關掉產品，待散熱風扇完全停止運作後才拔掉電源插頭。切勿依靠面板感測器關掉產品。
2. 長時間不使用時，應關掉本產品的電源及拔出電源插頭，避免因長時間通電導致內部電子組件損毀，引起火警。
3. 必須持產品清潔，並注意防蟲、防塵、防潮的保護，避免蟑螂等昆蟲進入電磁爐內部造成電路板短路。

## 1.2 防止火災或發生意外

### 為了避免發生意外，請注意下列事項

1. **注意！**在加熱時可能偶爾會噴濺出材料或熱水，這種現象稱為溢瀉。尤其是炆煮時，應使用低火力烹調及時刻留意食物烹調情況。
2. 如你是佩帶心臟起博器人士，請諮詢醫生意見。(使用本產品或會影響心臟起博器運作)
3. 保持鍋具平穩。(如果鍋具掉下來，可能會導致損傷或灼傷。)
4. 切勿過度加熱或乾燒空鍋。(食材可能會燃燒，繼而損壞鍋具。此情況有可能損壞本產品及其面板，甚至造成災害。)
5. 遠離大量熱氣、蒸氣或濕熱地方；切勿將產品靠近水源使用，防止機身進水。
6. 切勿用水直接沖洗產品機身、電源線或插頭，讓它們接觸到水或讓液體滲入產品帶電部分；在清潔時亦不可把部份或整部產品浸入水中，以免影響產品的安全性能及造成觸電的危險。再次使用產品前，必須確保插頭充分乾燥。
7. 小心使用電源線，切勿在電源線上放置重物或夾住電源線；切勿改裝、用力拉扯或扭曲電源線；在拔出或插入插頭時，應用手握穩插頭，並確保將插頭插穩。
8. 切勿將電源線懸掛在桌子、櫥櫃的邊緣或令它接觸發熱的表面。切勿在電源線纏結的情況下使用本產品，否則會加快電源線的損耗。
9. 本產品不能安裝在洗碗碟機、洗衣機、乾衣機、焗爐或冰箱之上，因為產品散發出的熱量或會損壞安裝於附近的電子設備。
10. 切勿於同一時間按下兩個或多個功能鍵，亦不要讓熱的物件置於控制面板，因為這會令產品出現錯誤的反應。
11. 切勿以濕手操作本產品，以及插入或拔除插頭。
12. 切勿將本產品用於烹飪以外的其他用途。(如用於烹飪之外的用途，則可能會發生故障。)
13. 本產品是家用或在類似環境使用，如：商店內部、辦事處以及其他類似工作環境的廚房區域；客戶在旅館、汽車旅館和其他住宅類型的環境。
14. 本產品只供家庭使用，切勿在室外使用或用作說明書建議以外的其他用途。如不當使用本產品，或作(半)商業用途，或未依照使用手冊操作，維修保養將告無效，本公司將不會承擔任何損壞的維修及賠償。
15. 當產品機身或零件出現故障，或不能正常操作，切勿自行使用或更換其他非生產商授權的零件或配件，以免發生危險，否則維修保養無效。
16. 遵從安全守則及避免釀成意外，如需檢查或維修產品，請聯絡信興電器服務中心有限公司(地址印於本使用說明書的背頁或致電 2406 5666)，並於檢查或維修時出示保修登記卡及收據。

### 1.3 使用電磁爐時

本產品會釋放出磁力線，請將任何易受磁力影響之物件遠離本產品

1. 收音機、電視機、助聽器等。(它們容易受到干擾。)
2. 磁卡、磁帶車票、銀行卡等。(它們的記錄可能被清除或損毀。)

切勿將本產品放置在其他電磁感應設備或任何金屬表面上／附近使用

1. 電磁感應電飯煲或煮食爐等。(磁場可能會損壞本產品。)
2. 切勿將本產品放在金屬檯面(或金屬表面)上使用，以免導致金屬材料或檯面被錯誤加熱而引起電磁爐機殼發熱，造成危險。

#### 加熱時鍋具發出噪音

如遇到以下情況，輕微轉動、移動或更換鍋具或有助減低共振及共鳴現象：

1. 根據鍋具類型的不同，可能會聽到鍋具的共鳴聲。
2. 握住鍋具手柄時，可能會感覺到微小的振動。
3. 加熱時移動鍋具，可能會聽到短促的金屬聲。

切勿在本產品下方的櫥櫃內存放調味料及食物

本產品排氣口釋放的熱量可能會使它們變質。

如酸性食物黏在面板或邊框上，應立即清潔

切勿讓醋、果醬、帶有檸檬汁的食物或梅子等食物黏在面板或邊框上。(否則，面板或邊框可能會褪色或受損。)

切勿用鍋底摩擦面板

面板可能會損壞或褪色。

切勿堵住進風口／排氣口

(進風口／排氣口被堵塞可能會造成過熱，導致產品自動關閉或引致其他災害。)

1. 進風口及排氣口分別位於本機底部及後方。
2. 切勿將本產品放置於地毯、檯布、紙品或墊子等物件上使用，以免堵塞進風口。如果堵塞進風口／排氣口，可能造成故障。
3. 切勿將金屬物件(如針或金屬線等)插入產品的任何位置，包括進風口／排氣口。

切勿使用蒸氣清潔器清潔本產品

若本機的帶電部件進水，則可能造成故障、漏電或其他傷害。

#### 1.4 使用[8]段火力加熱注意事項

1. 由於輸出功率大，如油量過少，鍋具會因此而快速受熱，油溫會因迅速上升而導致意外發生。
2. 高熱力輸出會造成鍋具底部彎曲變形。如使用的油量少或鍋具底部較薄時，應使用較低的火力段數預熱。
3. 燒水時，水一旦沸騰，應立即降低火力段(水可能會持續沸騰而溢出或噴濺。)
4. 若使用[8]段火力烹調食物並到達沸騰，切勿再加入新食材(由於輸出熱力太強，食料可能會煮沸溢出。)

## 2. 保養及清潔方法

1. 清潔前，先按[電源]鍵關上本產品及拔出插頭。
2. 面板的清潔：可用扭乾的濕布擦拭。如污漬擦不掉時，用稀釋的中性廚房去污粉或清潔劑清潔後，再用濕布擦拭即可。
3. 機身的清潔：可用柔軟濕布擦拭。如有油污難以清除時，用稀釋的中性廚房洗潔劑清洗後，再用濕布擦拭即可。
4. 切勿使用蒸氣清潔工具、用水直接沖洗或將產品及其電源線浸入水中清洗。如果本產品內部零件受潮，可能造成故障或其他災害。
5. 經長時間使用後，進風口或排氣口會積聚一些灰塵或油脂，並可能影響電磁爐運作。建議使用棉花棒進行定期清潔。
6. 如有果酸食物(例如：醋、果醬、帶有檸檬汁及梅子等食品)黏在面板或邊框上，應立即清理，否則可能引致褪色。
7. 如有任何塑膠物料、廚房用錫紙、糖類或含有糖的食品不小心融化於發熱的面板上，必須在面板仍是溫熱時用柔軟濕布擦拭，否則冷卻後才清潔或會損壞面板。
8. 切勿用水直接沖洗或將產品浸入水中清洗。如果本產品內部零件受潮，可能造成故障或其他災害。
9. 切勿使用堅硬刷子或百潔布刷洗爐面。
10. 切勿使用有機溶劑或苯等化學藥品擦拭產品及其面板／控制面板，以免發生化學反應。
11. 面板可能因使用不當(如使用底部不潔淨的鍋具加熱或加熱食材外溢且未及時擦淨)而產生發黃、發黑或劃痕等現象。經常清潔鍋具底部及產品面板，按說明書操作並做好日常保養，可避免或減少此類現象發生。
12. 如長期不使用本產品，請拔下電源插頭，進行清潔後套上塑膠袋並收藏於乾燥的環境。切勿將電源線纏繞在產品四周或壓住電源線，避免造成電源線磨損或破裂。
13. 注意防塵、防潮及防蟲的保護，避免蟑螂等昆蟲進入電磁爐內部造成電路板短路。

### 3. 鍋具的選擇

#### 3.1 合適的鍋具(磁鐵能夠黏在鍋具底部)

1. 材質：鐵或導磁不銹鋼的鍋具。必須使用註明“適合電磁爐煮食”的鍋具。
2. 形狀：底部直徑必須在12-20厘米範圍的鍋具，並與面板均勻接觸。
3. 鍋具重量(連盛載食物)每邊爐頭不能超過6公斤。



#### 3.2 不合適的鍋具(磁鐵不能黏在鍋具底部)

1. 材質：非鐵質金屬、不銹鋼(底部不能導磁)、陶瓷、玻璃、鋁或銅的鍋具。
2. 形狀：底部凹凸差距過大、有弧度、鍋底有支撐、鍋具底部為圓形及底部直徑小於12厘米或大於20厘米。另外，鍋具太輕、底部太薄或沒有明顯紋路亦不適合，因為鍋具可能於加熱過程中結焦、變曲或移動。
3. 即使標示為「適合電磁爐煮食」的陶製鍋具也不建議使用。因本產品可能無法有效分辨鍋具是否有磁性而無法加熱、操作不穩定、影響煮食效果或令產品啟動其保護功能及出現錯誤訊息。

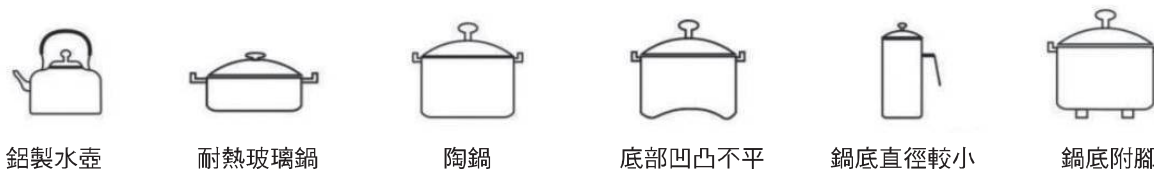

4. 切勿使用電磁爐導熱板。

### 4. 產品規格及結構

#### 4.1 產品規格

型號	RIC-S28DN
額定功率(約)	2,800W
額定電壓	220伏特~ 50赫茲
產品尺寸 (闊x深x高)(毫米)(約)	320 x 400 x 80
淨重(公斤)(約)	5
鍋具尺寸要求	底部直徑120-200毫米



## 4.2 產品結構

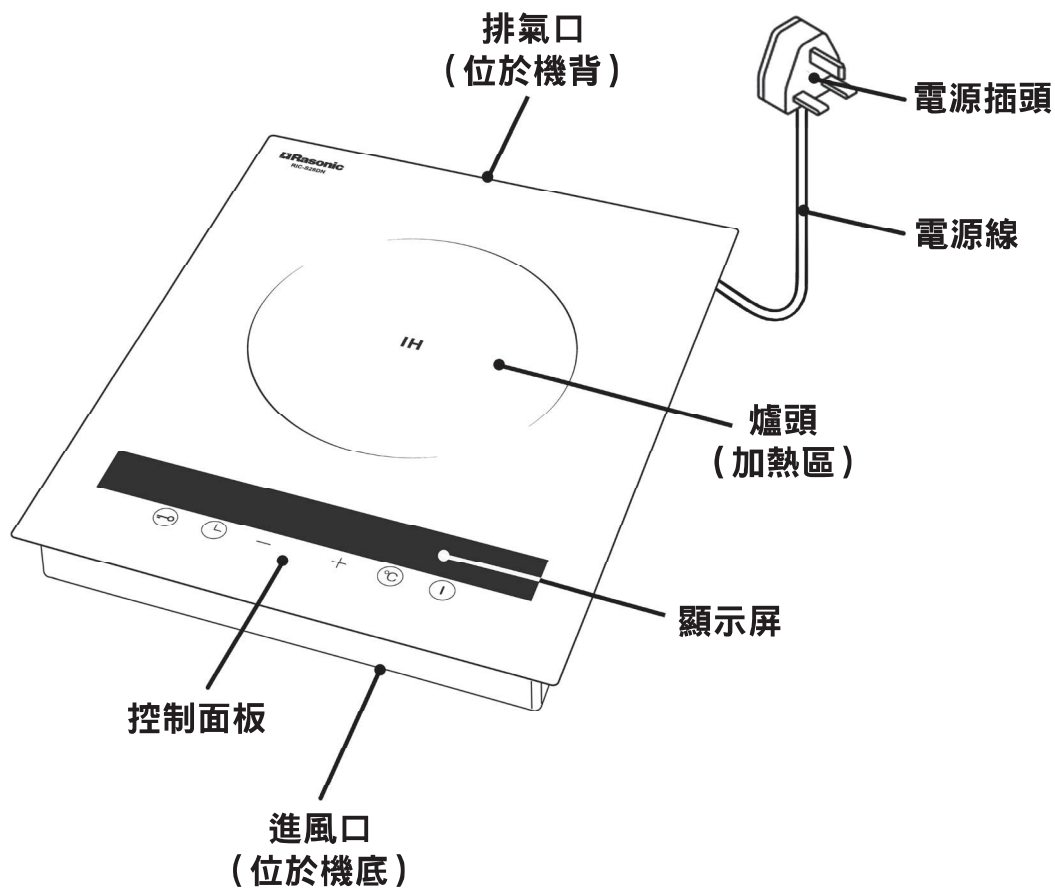

註：上述圖片僅供參考，尺寸比例或有差異，以實物為準。

## 5. 控制面板及操作方法

### 5.1 控制面板

#### 1. 面板設計

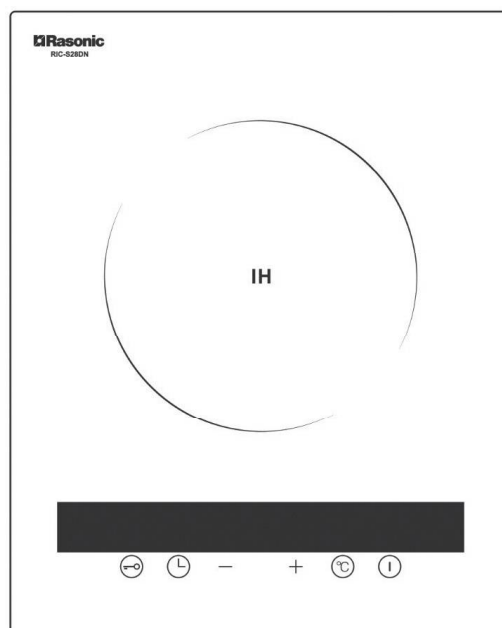

## 2. 控制面板

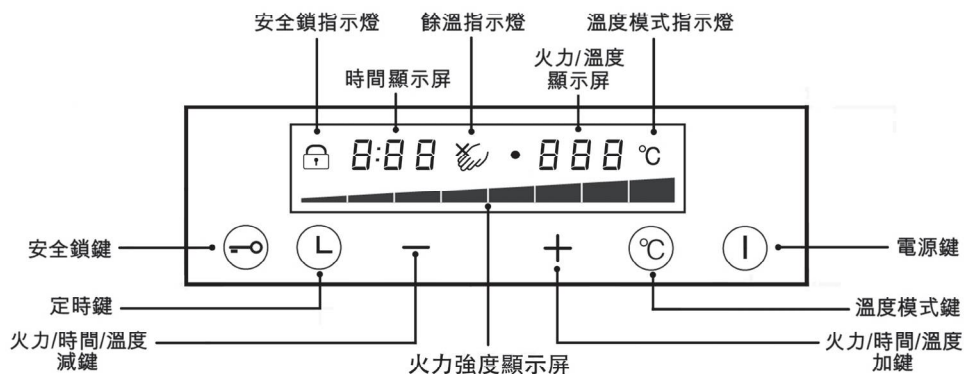

(注意：保持控制面板清潔乾爽，否則控制面板的電子感應功能可能會失效或造成錯誤運作。)

### 5.2 火力及溫度調控

火力段數	1	2	3	4	5	6	7	8
功率(瓦)	200	400	600	1000	1400	1800	2200	2800
溫度(°C)	60	90	120	150	180	200	220	240

\*\*\*注意！以上描述的火力及溫度段數，是對應實際功率和溫度於設定程序周期內的平均值。

接上產品電源，蜂鳴器鳴響一聲，顯示屏所有指示燈亮起，產品進入待機狀態。長按[]鍵使本產品進入備用狀態，火力/溫度顯示屏的「0」開始閃動。按[+]或[]鍵進入加熱狀態，產品開始運作。如用戶1分鐘內沒有按下任何功能鍵，顯示屏所有指示燈熄滅，產品返回待機狀態。

#### 火力設定

備用狀態下，放置合適的鍋具於面板的加熱區，按[+]鍵一次，火力顯示屏會出現預設火力[4]，火力強度顯示屏會顯示對應火力段數，表示本產品以第4段火力加熱。用戶可按[+]或[-]鍵自行調校合適的火力段數。本產品有八段火力段數可供選擇。



#### 溫度設定

備用狀態下，放置合適的鍋具於面板的加熱區，按[]鍵一次，溫度顯示窗會出現預設溫度[60°C]，即表示本產品以60°C溫度加熱。用戶可按[+]或[-]鍵自行調校合適的溫度段數。本產品有八段溫度段數可供選擇。



**注意：**烹飪過程中，用戶可按[]鍵於火力設定和溫度設定中自由轉換。

**注意：**如設定火力或溫度後未有放置合適的鍋具，本產品將會發出鳴響，顯示屏所設定了的火力段/溫度值會不停閃動以提醒用戶。若1分鐘內仍未有放置合適鍋具，產品會自動返回待機狀態。



## 定時功能





若需要設定烹飪時間(例如：蒸魚或煲湯等)，設定火力段／溫度值後，按[]鍵一次，時間顯示屏的[0:00]閃動，用戶可按[+]或[-]鍵調校時間，設定時間由1分鐘至8小時，完成後按[]鍵一次確認。若設定後10秒內未有按下任何鍵，有關時間設定亦將會自動確認。



當所設定的時間到達[0:59]後，多按一次[+]鍵，時間會轉為[1:00]，表示[定時]時間由59分鐘轉為1小時。長按[+]或[-]鍵可快速調整[定時]時間，由每次增加或減少1分鐘，加速至每次增加或減少10分鐘。選定後，若10秒內沒有按[]鍵，顯示屏的時間會停止閃動並自動確認，剩餘時間將以倒數計時方式顯示。當倒數完畢後，顯示屏會顯示[End]字樣，產品於蜂鳴器發出一聲鳴響後停止運作。



如用戶需要修改[定時]時間，可按[]鍵一次，剩餘時間會再次閃動，按[+]或[-]即可重新設置所需的[定時]時間。如用戶需要取消[定時]時間，可長按[]鍵2秒取消定時功能，產品會發出[嗶]聲；或直接按[]鍵關閉本產品。

## 安全鎖功能

在通電情況下，安全鎖處於解鎖狀態。長按[]鍵2秒以鎖定所有功能鍵，產品發出三聲[嗶]聲，顯示屏的安全鎖指示燈[]亮起，表示產品已進入鎖定狀態。如要解鎖，長按[]鍵2秒，蜂鳴器鳴響一聲，產品可重新啟動操作模式。

為防止兒童觸碰或意外觸碰而啟動或更改操作模式，使用加熱功能後，可長按[]鍵2秒鎖定功能鍵(包括[+]、[-]、[]鍵及[]鍵)使之不能更改火力、溫度或時間。在安全鎖啟動狀態時，顯示屏的安全鎖指示燈[]會亮起。

若同時啟動[定時]及[安全鎖]功能，顯示窗仍會顯示剩餘時間、火力段／溫度值，但所有功能鍵均會被鎖定([]鍵除外)。如需要恢復有關功能鍵，長按[]鍵2秒解鎖即可。

如用戶於鎖定狀態下直接按[]鍵停止加熱，產品會返回待機狀態，但安全鎖指示燈[]依舊會亮起，直至用戶解鎖為止。再次啟動本產品時仍處於鎖定狀態，用戶必須長按[]鍵解鎖才可啟動電磁爐及其他功能。如直接截斷電源再重新接上，[安全鎖]功能會自動解除，重新開啓後即可啟動運作。

## 自動關機功能

加熱過程中，如120分鐘內沒有按任何功能鍵或沒有定時設定，產品會自動停止加熱以確保安全。自動停止操作前會有一聲蜂鳴以提示用戶，然後返回待機狀態。如烹飪時間超過120分鐘，請使用定時功能。

## 散熱風扇延時轉動

加熱過程中，散熱風扇會一直轉動，直至用戶完成烹飪。按[]鍵一次關機，產品將返回待機狀態。**注意！**散熱風扇仍會轉動一段時間，用以排除機內的熱氣。

## 餘溫提示功能

完成烹飪及關機後，如爐面溫度處於約50°C或以上，餘溫指示燈[]會保持閃動，以提示用戶爐面尚有餘溫，切勿觸摸。

## 故障代碼

當產品使用不當或發生故障時，相關故障代碼會顯示於顯示屏上。(詳情可參考**標題6.故障排除**)當顯示屏出現E1-E7的故障代碼，產品會停止加熱同時蜂鳴器會鳴響，用戶須按情況處理有關問題。如有需要，可聯絡信興電器服務中心有限公司進行檢查及維修。

## 6. 故障排除

使用時，如發現產品操作上有問題，在維修前可先對照下表進行檢查及處理。

故障現象／錯誤代碼	檢查要點	處理方法
連接電源後，按[電源]鍵產品沒有反應，控制面板的指示燈沒有亮起。	住處是否停電？	待電力恢復後再使用。
	插頭保險絲是否斷開？	根據檢查要點小心檢查原因。如有需要，可聯絡信興服務中心有限公司進行檢查及維修。
	電源插頭有否鬆脫？	
產品不運作，並發出間歇蜂鳴聲。	鍋具是否電磁爐適用？	參考「 <b>章節3. 鍋具的選擇</b> 」選用電磁爐適用的鍋具。
	鍋具是否置於加熱區位置中央？	確保鍋具置於加熱區的中央位置。
	加熱過程中，鍋具是否經常被移走？	將鍋具放到加熱區適當的位置上。
錯誤代碼 E1/E2	輸入電壓與額定電壓是否不同？	確保使用當地電壓與本產品所標明的額定電壓相符。
錯誤代碼 E3	是否乾燒空鍋？	將鍋具移離產品，待鍋具及面板充分冷卻後再重新啟動本產品。
	加熱的食材是否溫度過高？	降低火力／溫度段數，或待冷卻後再嘗試重新啟動本產品。
錯誤代碼 E4	使用環境溫度是否過高？	待環境溫度下降後，再嘗試啟用本產品。
	進風口／排氣口是否被雜物或骯髒物遮蔽？	移開或清除遮蓋進風口／排氣口的骯髒物，保持通風口暢通。
	散熱風扇是否停止轉動？	聯絡信興服務中心有限公司進行檢查及維修。
	產品是否按安裝說明書建議安裝？	根據安裝說明書的指示安裝本產品，以確保通風管道暢通。
錯誤代碼 E5	爐面溫度感測器故障	聯絡信興服務中心有限公司進行檢查及維修。
錯誤代碼 E6	溫度感測器故障	聯絡信興服務中心有限公司進行檢查及維修。
錯誤代碼 E7	控制面板是否有積水？	用抹布將控制面板的積水擦乾。
	控制面板是否有抹布或被導電物體所遮蓋？	將抹布或導電物體移離控制面板。

如按照以上處理方法／操作仍未能修復問題，請即時關閉電源，聯絡信興電器服務中心有限公司(電話：2406 5666)進行檢查及維修，並將故障代碼告知信興電器服務中心有限公司。切勿自行拆卸及修理產品，避免產生觸電危險及對產品造成損害。

## 7. 特別聲明

1. 本資料上所有內容經過核對，如有任何印刷及內容上的誤解，本公司將保留解釋權。
2. 本產品若有技術改進，會編進新版說明書中，恕不另行通知；產品外觀、顏色如有改動，皆以實物為準。
3. 如本資料之中英文版本有差異時，應以中文版為準。
4. 使用說明書的電子副本可以通過電子郵件發送致客戶，如有需要，請致電信興電工工程有限公司：2861 2767。

## 8. 售後服務

由購買收據日期起之一年保修期內，經信興電器服務中心有限公司之服務人員證實產品於正常使用之情況下發生故障，本公司將提供免費維修或更換零件服務。經更換之任何損壞零件，將歸屬本公司所有。保修範圍不包括修理或更換玻璃面板、機殼、電源線、電源插頭及贈品鍋具等配件。如不當使用，或作為(半)商業用途，或未依照說明書使用，保修服務將無效，本公司將不會承擔任何損壞的維修責任及賠償。

用戶必須於維修時出示購買／換購收據及蓋有銷售點／換購中心印章的產品保修登記卡，如有任何疑問，請致電信興電器服務中心有限公司熱線查詢：2406 5666。

Thank you for purchasing Rasonic Kitchen Use Single-Burner Induction Cooker. Read the operation manual carefully before using and well keep it for your future reference.

## Table of Contents

1. Important Safeguards
2. Maintenance and Cleaning Methods
3. Cookware for Induction Cooker
4. Product Specifications and Configuration
5. Control Panels and Operation Instructions
6. Troubleshooting and Treatment
7. Special Avowal
8. After Sales Service

## 1. Important Safeguards

When using the appliance, please follow the basic safety precautions, inappropriate use may lead to personal injury and damage to property.

### 1.1 To prevent fire, burn or electric shocks

#### Before using the induction cooker

- 1 Do not connect with other high wattage appliance under the same socket, and make sure the input voltage match the rated voltage marked on the appliance before operation.
- 2 Do not use power extension cords to avoid overload and risk of fire.

#### When install the induction cooker

1. For 2800W induction cooker, make sure to connect the power plug of the appliance to a 13A socket. If fixed wiring connection is needed, connection must be incorporating with an individual switch with 13A or above in accordance to the Electricity Ordinance.
2. The appliance should be placed on a dry area steadily and at least 100 mm away from the wall for ventilation. For built-in installation, leave at least 80 cm<sup>2</sup> spacing for air intake/exhaust vent and at least 150 mm between the appliance to the attachment below. Keep clear of the air intake and exhaust vent.

#### When stir-frying with induction cooker

1. Do not overheat. (Use lower heat levels for preheating.)
  - If small amount of oil is used and being heated excessively, oil temperature will rise rapidly and may scorch to the cookware or catch fire.
  - If the bottom of the cookware is thin or curved, it may become red-hot.
2. Do not leave the appliance unattended. Especially when cooking on a pot with fat or oil can be dangerous and may result in a fire.
3. Never heat an empty cookware alone. Otherwise the appliance may overheat, malfunction and top plate discolor.
4. The cooking process has to be supervised. A short term cooking process has to be supervised continuously.

#### The top plate and the top frame become very hot

1. Do not touch the appliance during or after use for a while. (Especially when the hot caution indicator  lights up.)
2. Clean the appliance after cooled down. (Avoid touching the top plate after use for a while because high temperature remained due to the heat of cookware.)

#### For the top plate

1. Do not place portable gas burners, petroleum gas cylinders or canned food on the top plate. They may explode if they are mistakenly heated.
2. Use cookware with a flat and clean bottom as mentioned in the manual only, and ensure it is steadily placed onto the top plate. Otherwise, the sensor of the appliance may be malfunction and causes abnormal heating.
3. Metallic objects or magnetic materials such as knives, forks, spoons, lids, aluminum foil/tray, retort pouch, magnetic ring, watch or accessories should not be placed on or near the surface of the top plate, or in contact with the cookware when the appliance is operating; otherwise, they may get hot. (They may cause burns or injuries by heat generated.)

4. Do not subject the appliance to a crash. (e.g. Dropping heavy object on the appliance may cause invisible cracks under the top plate. Without checked by Shun Hing Electric Service Centre Limited but kept using the appliance may cause further cracks and danger.)  
**\*\*\* WARNING!** If the top plate is cracked due to subjection to a crash or heavy object felt, stop using immediately, switch off the appliance and unplug the appliance. In order to avoid the possibility of electric shock, short circuit or fire, contact Shun Hing Electric Service Centre Limited immediately for checking and repairing.

#### For the cookware

1. Specific cookware should be used on induction cooker only. Do not attempt to use it on gas cookers. Never use it alternatively as it may affect the cooking result.
2. Before placing cookware on the top plate, make sure that there is no water, oil or other attachment in between. If so, clean it before using the appliance.

#### Avoid deep-frying cooking

1. When deep-frying, overheated oil may catch fire and damage the electrical components because the appliance does not equip with oil temperature control system. Always heat fat or oil bit by bit, and keep watching as it heats up.
2. If oil or fat catches fire, switch off the appliance immediately. Do not put out the flames with water. Use suitable fire extinguisher or fire blanket instead.

#### For the induction cooker cooking burner

1. To avoid hazard occur, do not place the appliance on top of any metallic plates (or metal surfaces). Prevent the metallic materials from getting hot or the appliance enclosure may get hot by the temperature increase of the material surfaces.
2. Keep all combustible materials, spray canisters and aerosols away. It may possibly cause fire or explosion.
3. Do not allow people who is unaccustomed to use the appliance without supervision.
4. The appliance is not intended to use by peoples (including children) with reduced physical, sensory or mental capabilities, or lack of experience and knowledge, unless they have been given supervision or instruction concerning the use of the appliance by the person responsible for their safety.
5. Do not heat any canned food directly to avoid explosion caused by air expansion.
6. Pay attention to the cooking status and temperature to avoid overheating or empty heating. Otherwise, the overheat protection will be activated and the appliance will be shut off automatically when the temperature is too high. It may affect the cooking result.
7. Great care is necessary in using the appliance, especially near children. Children should be supervised to ensure that they do not play with the appliance. Also, children without adult supervision should not operate the appliance and keep them away from the appliance and its power cord.
8. Keep it out of reach for infants.
9. Do not insert metallic object (such as pins or wire etc.) into the air intake/exhaust vent.
10. The appliance is not intended to be operated by means of an external timer or separate remote-control system.
11. Heat the bottom of the cookware directly. Never place paper or other objects between the cookware and the top plate. (Objects may possibly get burnt due to high temperature.)
12. Always place the cookware at the center of the cooking zone during operation.
13. Do not disassemble, attempt to repair or modify the appliance. For checking or repairing, contact Shun Hing Electric Service Centre Limited.
14. If the power cord is damaged, it must be replaced by Shun Hing Electric Service Centre Limited to avoid hazard.



**Switch off the main power after use**

1. After use, switch off the appliance by pressing [Power] key. After the operation of the cooling fan prolong function, unplug the appliance from the socket. Do not rely on the pan detector to turn off the appliance.
2. When not in use for a long time, shut down and unplug the appliance to avoid damaging the electrical components or even causing fire due to long-term connect to the electricity.
3. Keep the appliance clean, pay attention to pest control, dust and moisture protection. Protect the appliance against cockroaches and other insects from entering the interior of the appliance to avoid short circuit.

**1.2 To prevent ignition or accidents****Beware of the following in order to avoid accidents**

1. **ATTENTION!** Ingredients or hot water may spout infrequently during heating. This phenomenon is called bumping. Check the condition carefully and stir the ingredients occasionally by using low power levels, especially when simmering.
2. If you wear a cardiac pacemaker, consult with doctor for medical advice. (The operation of the appliance may affect the pacemaker.)
3. Cookware must be placed on the top plate steadily. (If the cookware fell off, it may cause injuries or burns.)
4. Never empty heating or overheating the cookware. (Ingredient may get fire or damage the cookware. It may also damage to the appliance and the top plate, or lead to other hazards, etc.)
5. Keep the appliance away from the place of massive hot gas, steam, damp and heat place or water source so as to prevent water penetrating inside the appliance.
6. Do not rinse the appliance, the power cord or the plug with water directly. Do not let it get in touch with water or allow liquid to penetrate the electrical components of the appliance. Do not immerse part or the whole appliance into water when cleaning. Otherwise it may affect the insulated parts and cause a risk of electric shock. Make sure the power cord is dry before use.
7. Handle the power cord with care, do not place heavy objects on or clamp it. Any modification is prohibited to the power cord. Do not stretch or twist the power cord. Always hold the plug tightly when unplugging or plugging into the socket.
8. Do not hang the power cord over the edge of table, counter-top or contact with the hot surfaces. Do not use the appliance when the power cord is tangled, it may let the power cord be frayed and damaged.
9. Do not install the appliance above the dishwasher, washing machine, dryer, electric oven or refrigerator. It is because emission of heat could damage other electrical appliances underneath.
10. Make sure to press one function key at a time only. Do not place hot objects or cookware on the control panel as the appliance may function improperly.
11. Do not touch the appliance, plug or unplug the power cord by wet hand.
12. Do not use the appliance for purposes other than cooking. (Using the appliance other than cooking may cause malfunction.)
13. The appliance is intended to be used in household or similar environments such as: staff kitchen area in shops, offices and other working environments; or clients in hotels, motels and other residential type environments.
14. The appliance is for household or similar environment uses only. Do not use it outdoors and any other uses that are not recommended in the manual. If the appliance is used improperly or for commercial (or semi-commercial) purpose or if it is not used according to the instruction in the manual, the maintenance guarantee will become invalid and we refuse any liability for damage caused.
15. To prevent hazards occur, when the appliance or parts were malfunction, do not replace with any parts or accessories which is produced without authorization. Otherwise, the maintenance guarantee will become invalid.

16. In order to comply with safety regulations and to avoid hazards, if the appliance needs to be checked or repaired, contact Shun Hing Electric Service Centre Limited (**hotline at 2406 5666 or refer to the address found at the back page of the manual**), and be reminded that the official invoice and warranty registration card must be presented for checking or repairing service.

### 1.3 When using the induction cooker

**The appliance emits magnetic lines of force. Please keep the below items away as if affected by magnetism**

1. Radios, TVs, hearing aids, etc. (They will be susceptible to noise.)
2. Magnetic card, automatic turnstile tickets, bank cards, etc. (The records may be erased or damaged.)

**Do not place the appliance on top of or next to other induction cooking appliances or metallic plates**

1. Induction rice cooker or induction cooker, etc. (The magnetic field may damage the appliance.)
2. Do not place the appliance on top of any metallic plate during operation. Otherwise, it may damage the appliance, or cause fire and other hazards.

### Noise generated by cookware when heating

If the following situation happens, it may help to alleviate the sound and vibration if the cookware is slightly moved, rotated or replaced:

1. Resonant sounds may be heard depending on the type of cookware.
2. When holding the handle, user may feel a small vibration.
3. If the cookware is moved when heating, a short metallic sound may be heard.

### Do not place seasoning or food in the cabinet (located below the appliance)

The heat emission from the exhaust vent may spoil them.

### If acidic food sticks on the top plate or top frame, wipe it off immediately

Do not let the residual vinegar, jam or food containing lemon juice or plum sticks on the top plate or top frame. (Otherwise, the top plate or top frame may be discolored or damaged.)

### Do not rub the top plate against the bottom of cookware

The top plate may be scratched or discolored.

### Do not clog up the intake/exhaust air vent

(When the intake/exhaust air vent is clogged, the appliance may turn off automatically and overheat may cause other hazards.)

1. The intake and exhaust air vents can be found at the bottom and the back of the appliance.
2. Do not place the appliance on top of carpet, tablecloth, paper sheet or mat etc. If the intake/exhaust air vent is clogged, it may cause malfunction.
3. Do not insert metallic object (such as pins or wire etc.) into the appliance, especially intake and exhaust air vents.

### Do not use steam cleaner to clean the appliance

If water penetrates to the electrical components inside the appliance, it may cause malfunction electricity leakage or other hazards.

#### 1.4 When using the power level [8]

1. The appliance is with strong heating power. If high power level is used in small portion of oil, the cookware may be heated excessively. Oil temperature will rise rapidly and may cause accident.
2. If the bottom of the cookware is thin, overheat may result in cookware deformation. Therefore, preheat the cookware with low power level when using thin bottom cookware or small portion of oil.
3. When boiling water, turn down the power level as soon as the water was boiled. (Water may boil over or splash around.)
4. When cooking in [8] power level, do not put ingredients in the cookware. (The heating power is very strong as the ingredients may boil over.)

## 2. Maintenance and Cleaning Methods

1. Switch off the appliance by pressing [Power] key and remove the power plug from the socket before cleaning.
2. Cleaning of the top plate: When the top plate is dirty, use a wretched damp cloth to wipe. If object can not be wiped off, use some mild decontamination powder or detergent to wipe, then using a damp cloth to wipe.
3. Cleaning of the main unit: When the main unit is dirty, use a soft damp cloth to wipe. If the greasiness is hard to wipe off, use some mild decontamination powder or detergent to wipe, then using a damp cloth to wipe.
4. Do not use a steam cleaner, rinse the appliance and its power cord with water directly or to dip the appliance into water. If water penetrates the electrical parts built into the unit, it may cause malfunction or other hazards.
5. After using a long time, dust and grease may accumulate on the intake/exhaust air vent which may affect cooker's operation. Clean the appliance regularly and make use of cotton stick.
6. If acidic food (e.g. vinegar, jam or food containing lemon juice or plum, etc.) sticks to the top plate or top frame, wipe it off immediately. Otherwise, the top plate or top frame may be discolored.
7. Materials including plastic, aluminum foil, sugar, or any foodstuff contains sugar are already burnt on or melted on the cooking zone unintentionally. It must be removed or cleaned immediately with soft damp cloth when the top plate is still warm. Otherwise, it may damage the top plate when cool down.
8. Do not rinse the appliance with water directly or dip the appliance into water. If water enters the electrical components build into the main unit, it may cause malfunction or other hazards.
9. Do not use hard brush or scouring pad to clean the top plate.
10. Do not use any chemicals such as organic solvent or benzene to wipe the top plate/control panel, so as not to make chemical reaction.
11. Top plate may suffer from damages such as color changes to yellow, black or scratched for improper use (e.g. cook with dirty bottom cookware or do not clean immediately after the overflow of soup etc.). User can avoid or reduce such phenomena if user operate according to the manual and do daily maintenance.
12. Disconnect the power plug when the appliance not in use for long time. Store in a dry place, and clean it before packing it in a plastic bag. Never wrap the power cord tightly around the appliance or put any pressure on the power cord when the appliance is stored as it could cause the power cord to fray and damage.
13. Pay attention to pest control, dust and moisture protection. Protect the appliance against cockroaches and other insects from entering the interior of the appliance to avoid short circuit.

### 3. Cookware for induction cooker

#### 3.1 Suitable Cookware for Induction Cooker (A magnet can be stuck at the bottom of cookware)

1. Material: Cookware is made of iron or magnetic stainless steel. It is necessary to use the cookware stated "Suitable for induction cooking".
2. Shape: Flat bottom base cookware with the diameter in between 12-20 cm and can contact evenly with the top plate.
3. Weight: The maximum weight (including ingredients) must not exceed 6 kg.

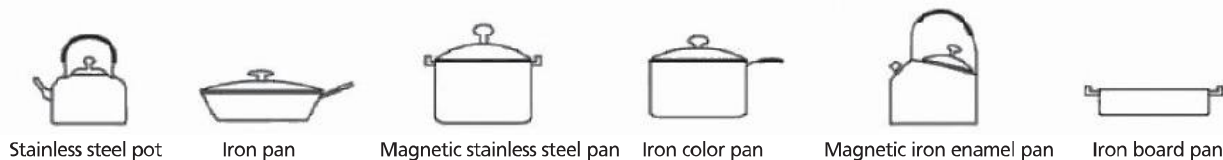

#### 3.2 Unsuitable Cookware for Induction cooker (Non-magnetic Cookware – A magnet cannot be stuck to the bottom of cookware)

1. Material: Cookware base is made of non-ferric metal, stainless steel with non-magnetic base (A magnet will not stick to the bottom of cookware), ceramic, glass, aluminum and copper.
2. Shape: Uneven base, curved, has protrusions or legs; the bottom of the cookware is round. And the bottom diameter is less than 12 cm or larger than 20 cm. Too light, too thin bottom or base without clear grooves cookware is unsuitable too because it may get scorched, warped or cause movement during heating.
3. Ceramic cookware such as earthen cookware is not suggested to be used, even they are stated "Suitable for induction cooking". Since it is hard to distinguish whether the cookware is magnetic or not, which may result in malfunction, unstable operation, improper cooking, activation of the safety protection function or even operation errors may occur.

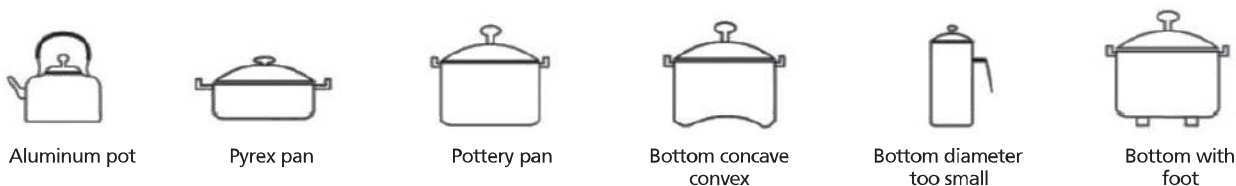

4. Do not use the magnetic plates.

## 4. Product Specifications and Configuration

### 4.1 Product Specifications

Model	RIC-S28DN
Rated Power (approx.)	2,800W
Rated Voltage	220V~ 50Hz
Unit dimensions (W x D x H) (mm) (approx.)	320 x 400 x 80
Net weight (kg) (approx.)	5
Required cookware size	Base diameter 120-200mm

## 4.2 Product Configuration Front Side

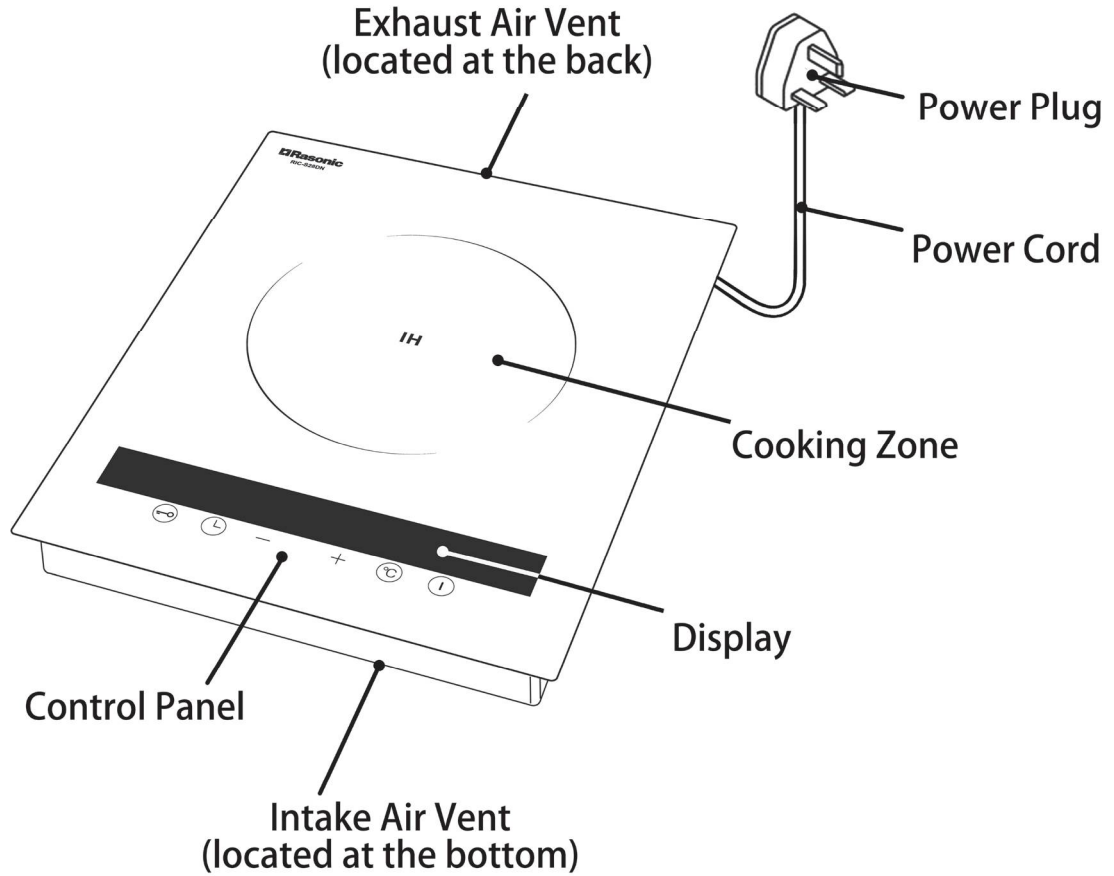

Remark: The above illustrations are for reference only. Size may differ from real object and subject to the actual appliance.

## 5. Control Panels and Operation Instructions

### 5.1 Control Panel

#### 1. Top plate design

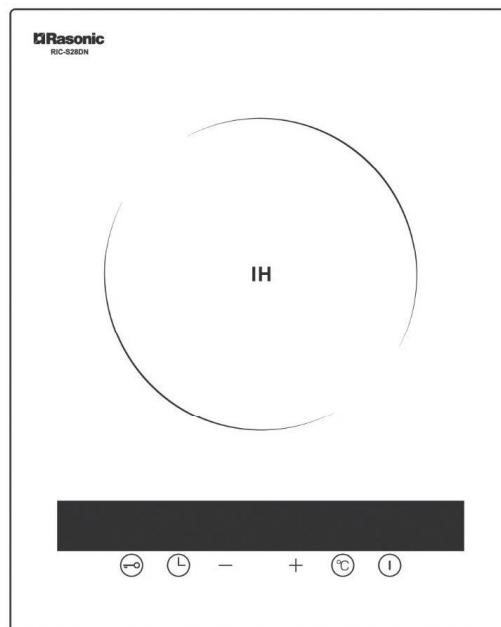

## 2. Control Panel

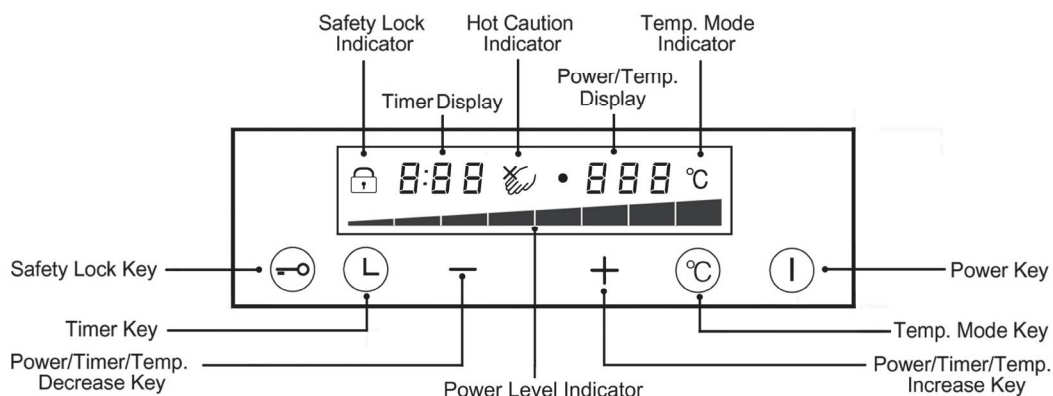

(Remarks: Keep the control panel clean and dry. Otherwise, the electronic sensor of the keys will be program fault or malfunction.)

### 5.2 Power and Temperature Control

Power level	1	2	3	4	5	6	7	8
Power (W)	200	400	600	1000	1400	1800	2200	2800
Temperature (°C)	60	90	120	150	180	200	220	240

\*\*\* **Note:** The power and temperature shown above is the mean value of the actual power and temperature in a desired operation period.

After inserting the plug into the socket, all the indicators light up and the appliance enters standby mode. Long press the [0] key, "0" will be flash on power/temp. display. User can press either [+] or [°C] key to start the operation. The appliance will be shut off automatically if no function key is pressed within approx. 1 minute. All the indicators closed and the appliance will return to standby mode.

#### Power control

In standby mode, place a suitable cookware at the cooking zone, then press the [+] key, power display will show [4] and power level indicator will show the power level correspondingly meaning that the appliance is now operating under default power level 4. User can press the [+] or [-] key again to adjust a desired power level. There are totally 8 power levels for selection.

#### Temperature control

In standby mode, place a suitable cookware at the cooking zone, [Temperature] function can be activated by pressing the [°C] key, temp. display will show [60°C] meaning that the appliance is now operating under default temperature control 60°C. User can press the [+] or [-] key again to adjust a desired temperature level. There are totally 8 temperature levels for selection.

**Remark!** User can interchange power control and temperature control by pressing [°C] key during operation.

**Remark!** If no suitable cookware is placed at the cooking zone, "Beep" sound will keep emitting even power/temperature levels have been set. The power/temperature level indicator will keep flashing to remind user. The appliance will return to idle mode automatically if no suitable cookware placed within 1 minute.

## Timer Setting

When using the timer function (such as steaming fish or cooking soup), after selecting the power/temperature level, press the [⏸] key, timer display will show the default time setting [0:00] and the numbers will flash on display. User can adjust the time by pressing [+] or [-] key, circulating from 1 minute to 8 hours. Press the [⏸] key to confirm, or the timer setting will be automatically confirmed after 10 seconds.

When time setting comes to [0:59], display will change to [1:00] if [+] key is pressed once again, meaning that the setting time changed from 59 minutes to 1 hour. To speed up the adjustment, user can press and hold the [+] or [-] key to advance rapidly; changing from 1 minute to 10 minutes by increment or decrement. When approx. 10 seconds elapsed without any modification, the timer setting will be confirmed automatically, the numbers in the display will stop flashing. Remaining time will be shown on the display and will start counting down. When the count down is finished, the operation is finished after a [Beep] sound is emitted and [End] will be shown on the display.

If new setting time is needed, user can press the [⏸] key once, numbers on the display will flash again and press the [+] or [-] key to reset the [Timer]. The appliance will confirm automatically 10 seconds after completion of the setting.

Timer function can be cancelled by pressing the [⏹] key or long pressing [⏸] key for 2 seconds, a [Beep] sound will emit afterwards.

## Safety Lock

The lock is deactivated in standby mode. Long press the [⏹] key for 2 seconds, 3 [Beep] sounds will emit and safety lock indicator [🔒] will light up on the display, meaning all function keys are locked. To deactivate the lock, long press the [⏹] key again for 2 seconds and a [Beep] sound will emit. The appliance will resume for operation.

To prevent children from accidentally operating the appliance or changing the function modes, long press the [⏹] key for 2 seconds during operation, safety lock indicator [🔒] will light up in the display, all the function keys are locked (including [+], [-], [°C] and [⏸] keys) where the operating power control, temperature control and time can not be adjusted. When the safety lock is activated, the safety lock indicator [🔒] will light up on the display.

If both [Timer] and [Lock] are activated, display will show the remaining time setting but all the function keys are locked (except [⏹] key). Long press the [⏹] key for 2 seconds to deactivate the safety lock and all the function keys will be unlocked.

If stop the operation directly by pressing the [⏹] key, the safety lock indicator [🔒] will still light up until deactivation of the lock. User must long press the [⏹] key to unlock before next operation; otherwise, the lock function will remain active. If cut off the power supply directly, the safety lock will be deactivated and all the function keys will be unlocked when re-connecting the electricity again.

## Absent-minded shut down protection

When approx. 120 minutes elapsed without any external interruption during operation, a [Beep] sound will emit and the appliance will return to standby mode as safety protection. Make use of the timer function if the operation time longer than 120 minutes.

## Cooling Fan Prolong Operation

Press the [⏹] key to stop operation, the appliance will go to standby mode and the [Power] indicator above will change from lighting to flashing. **ATTENTION!** The cooling fan will continue to operate in order to suppress the temperature rise in the main unit. The fan will be automatically turned off when the cooling function finished.

## Hot Caution Symbol

After finishing the operation, if the temperature of top plate reaches 50°C or above, the hot caution indicator [🔥] will be statically lighted up, meaning that the top plate still hot, do not touch it.

## Error Code

When there are some problems or using the appliance improperly, the respective error code will be shown on the display. The operation will stop and generate discrete [Beep] sounds if error code E1-E7 are shown on the display. (Refer to the check points and remedy shown on **Chapter 6. Troubleshooting and Treatment**)

User can deal with the problem accordingly. If necessary, contact Shun Hing Electric Service Centre Ltd. for checking and repairing.

## 6. Troubleshooting and Treatment

During operations, if any error occurred, check the following table before calling for service. Below are common errors and the checks to perform.

Symptoms/Error Code	Check points	Remedy
After connected to the electricity, no respond when pressing the [Power] key and no indicator on the control panel.	Is the power suspension?	Use the appliance after electricity resumed.
	Is the fuse burnt out?	Check the root cause carefully. If the error cannot be fixed, contact Shun Hing Electric Service Centre Ltd. for checking and repairing.
	Is the power plug not firmly connected to the socket?	
No operation. Buzzer sounds discontinuously.	Is the cookware used incompatible?	Follow the instructions in " <b>Chapter 3. Cookware for induction cooker</b> " to choose suitable cookware.
	Is the cookware not placed at the centre of the cooking zone?	Place the cookware at the center of the cooking zone.
	Is the cookware being moved during operation?	Place the cookware on the cooking zone when using.
Error code E1/E2	Is the input voltage match with the rated voltage of the appliance?	Make sure the local voltage matches the rated voltage of the appliance.
Error code E3	Is it heating empty cookware?	Move the cookware apart. Let it cool down together with the top plate before next operation.
	Is the ingredients overheated?	Lower the power/temperature level, or switch on the appliance again when it is cooling down.
Error code E4	Is the ambient temperature too high?	Switch off the appliance and restart when it is cooling down.
	Is the intake/exhaust air vent clogged or blocked by dirt accumulated?	To ensure good ventilation, remove the dirt clogged in the intake/exhaust air vent.
	Is the ventilation fan malfunction?	Contact Shun Hing Electric Service Centre Ltd. for checking and repairing.
	Is it the appliance installed ignoring the instructions stated in installation manual?	Follow the instructions stated in the installation manual, and install the appliance with good ventilation.



Error code E5	Top plate temperature sensor error	Contact Shun Hing Electric Service Centre Ltd. for checking and repairing.
Error code E6	Temperature sensor error	Contact Shun Hing Electric Service Centre Ltd. for checking and repairing.
Error code E7	Is there any water accumulated on the control panel?	Wipe the control panel by soft dry cloth.
	Is there any cloth or conductivity objects covering the control panel?	Take the cloth or conductivity objects away from the control panel.

If the above remedies/solutions cannot fix the problem, unplug the appliance immediately, contact Shun Hing Electric Service Centre Ltd. (Tel: 2406 5666) for inspection and repairing, and report the error code to service centre technician. To avoid any danger and damage to the appliance, do not disassemble or repair it by yourself.

## 7. Special Avowal

1. The information above has been checked; our company reserves the hermeneutic power to any print errors or misunderstanding on the content.
2. Please note that any technology improvement will be added to the new versions of operation manual without any prior notices. The product appearance and color are subject to the actual appliance.
3. In case there is any inconsistency or conflict between the English versions and Chinese versions of the terms, the Chinese versions shall prevails.
4. E-copy of user manual can be sent by e-mail on request, please call Shun Hing Electric Works & Engineering Co., Ltd. at 2861 2767.

## 8. After Sales Service

For any defect, in the judgment of technician from Shun Hing Electric Service Centre Limited, caused under normal use, our company is responsible for repairing or replacing any parts of the said electrical appliance free of charge within one year guarantee period commencing from the date of purchase. Any defective part which has been replaced shall become our property. Warranty service does not cover the repair or replacement of parts such as top plate, enclosure, power cord, power plug and cookware supplied etc. If the appliance is used improperly, for commercial or semi-commercial use, or not following the instructions in the operation manual, the warranty becomes invalid and our company will refuse any liability and repairing cost for the damage caused.

User must present the official invoice/redemption voucher and the product warranty card with the chop from sales point/redemption center for maintenance. For enquiries, please call Shun Hing Electric Service Centre Limited hotline at 2406 5666.



SHUN HING GROUP  
信興集團  
SINCE 1953

**Rasonic 樂信牌**

## 信興電工工程有限公司

**SHUN HING ELECTRIC WORKS AND ENGINEERING CO., LTD.**

辦公室：香港九龍尖沙咀東部麼地道67號半島中心9樓

電話：2861 2767

圖文傳真：2865 6706

網址：<http://www.rasonic.com>

電郵：[shew@shunhinggroup.com](mailto:shew@shunhinggroup.com)

Office: 9/F, Peninsula Centre, 67 Mody Road, Tsimshatsui East, Kowloon, Hong Kong

Tel: 2861 2767

Fax: 2865 6706

Website: <http://www.rasonic.com>

E-mail: [shew@shunhinggroup.com](mailto:shew@shunhinggroup.com)

保養及維修 Maintenance and Repair Service:

## 信興電器服務中心有限公司

**SHUN HING ELECTRIC SERVICE CENTRE LTD.**

香港新界葵涌勝耀街2號信興中心11樓

服務熱線：2406 5666

傳真號碼：2408 0316

網址：<http://www.shesc.com/zh>

11/F, Shun Hing Centre, 2 Shing Yiu Street, Kwai Chung, N.T. HK

Service Hotline: 2406 5666

Fax No.: 2408 0316

Website: <http://www.shesc.com/en>

客戶服務中心：

香港新界葵涌勝耀街2號信興中心1樓

九龍尖沙咀東部麼地道67號半島中心B座9樓

香港天后琉璃街7號柏景中心22樓

澳門慕拉士大馬路193-199號南嶺工業大廈5樓1座

Customer Service Centre

1/F, Shun Hing Centre, 2 Shing Yiu Street, Kwai Chung, N.T.

9/F., Block B, Peninsula Centre, 67 Mody Road, Tsim Sha Tsui East, Kowloon

22/F, Parkview Centre, 7 Lau Li Street, Tin Hau, Hong Kong

Avenida de Venceslau de Morais, No. 193-199,5 andar - I, Edf. Industrial Nam Leng, Macau

有關最新之香港及澳門客戶服務中心資料，請參閱信興服務中心網址：<http://www.shesc.com/zh>

For the latest information of Hong Kong and Macau service center, please visit <http://www.shesc.com/en>